

ILCO - Replacement Cylinders

Universal Knob / Lever Locksets

15395 - 6 pin Cylinder Keyed 5 Pin

For use on Schlage A & D levers
Falcon F series levers
TAH LSV series

Stocked Keyways

- Schlage C
- Schlage E
- Schlage C-K

Stocked Finishes

US26D

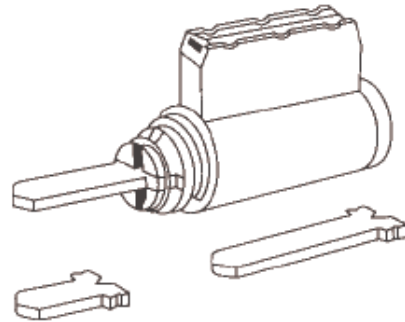

Rim Cylinders

7015 - Rim Cylinders

Solid brass cylinders are ideal for use on 1-3/8" to 2-1/4" thick door.
Each cylinder is furnished with trim ring, mounting plate & break off screws.
All cylinders drilled 6 pin - 5 pin keyed.

Stocked Keyways

SC = SCHLAGE C
SE = SCHLAGE E
SX = SCHLAGE C-K

Stocked Finishes

US10B, US26D, US3
US10B, US26D, US3
US10B, US26D, US3

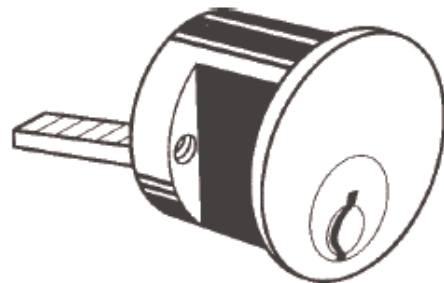

Dummy Mortise Cylinders

Stocked Products

- Dummy Rim Part # 7010
- Dummy 1-1/8" Mortise # 7180
- Dummy 1-1/4" Mortise # 7200

Stocked Finishes

10B, 26D
10B, 26D
10B, 26D



1-877-930-1192

ILCO - Replacement Cylinders

Thumb-turn Mortise Cylinders

Stocked Products

- 7181 1-1/8" Length
- 7201 1-1/4" Length

Stocked Finishes

- 10B, 26D
- 26D

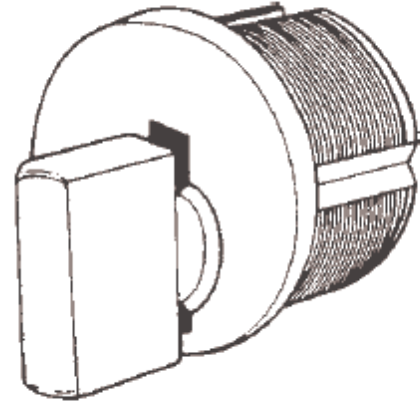

Mortise Cylinders

- 7185 1-1/8" Mortise Cylinder
- 7205 1-1/4" Mortise Cylinder

Machined from solid bar brass. This line offers a broad selection of keyways. Threadsize is 1.150" x 32 UNS. All cylinders drilled 6 pin - 5 pin keyed with standard cam

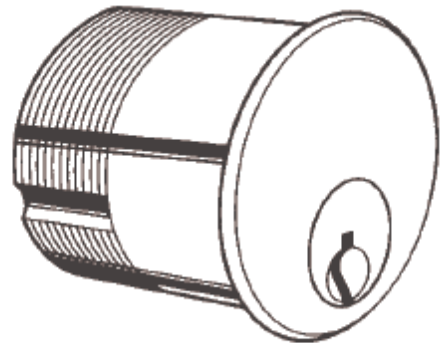

STOCKED KEYWAYS

SC = SCHLAGE C
SE = SCHLAGE E
SX = SCHLAGE C-K

STOCKED FINISHES

US10B, US26D
US10B, US26D
US10B, US26D

* KWIKSET ONLY STOCKED IN 1-1/8" LENGTH

1-877-930-1192

ILCO - Replacement Cylinders

Adjustable Spring Collars

• 861A 5/16" - 13/32" Adjustment, Brass Material, Satin Chrome



9ILC861A



SOLID COLLARS

861D 1/8" alum, duro

861F 1/4" alum, duro



9ILC863A
Adams Rite Cam



9ILC863G
Standard Cam



9ILC863M
Schlage L Cam

Look Alike Keyblanks

Best "A"
KB1A1A1

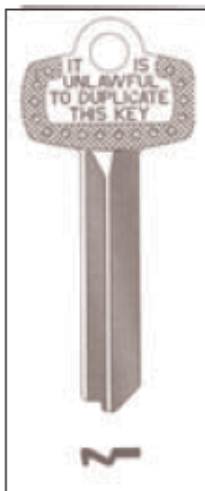

Nickel Silver
6 or 7 PIN
"A" Keyway

Kwikset
KB1063KW



Nickel Plate
5 PIN

Schlage 5 Pin
KB100C

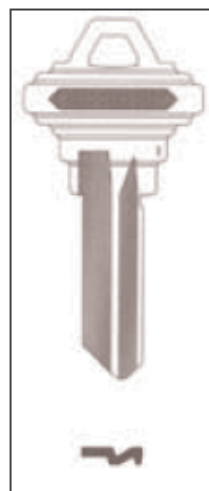

Nickel Silver

Schlage 6 Pin
KB101C

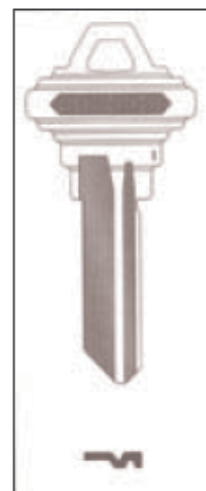

Nickel Silver

1-877-930-1192