

Camden - Key Switches

CM1120 - Flush Mount Key Switch 1 SPDT Momentary

CM1130 - Flush Mount Key Switch 1 SPDT Maintained

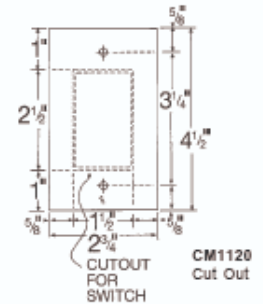
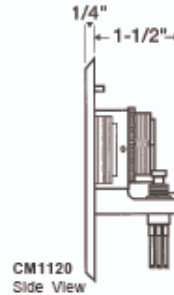
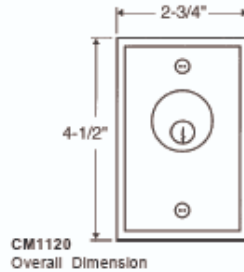

CM2020 - Narrow Style Key Switch 1 SPDT Momentary

CM2030 - Narrow Style Key Switch 1 SPDT Maintained

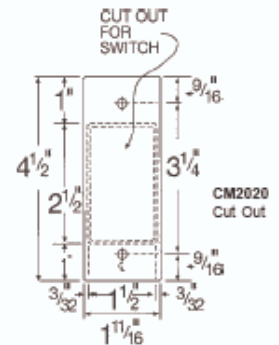
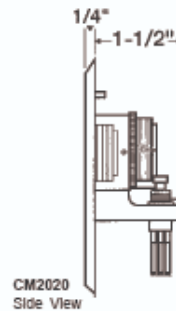
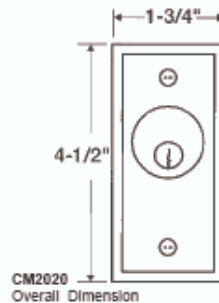

Features:

Keyswitches are supplied with aluminum face plate, cylinder locking ring, 2 socket / slotted screws, 2 tamper proof screws.

CM2020 supplied with rubber gasket. Designed to use 1", 1-1/8", or 1-1/4" mortise cylinders.

MORTISE CYLINDER NOT SUPPLIED

Stocked Product

CM1120 - SPDT Momentary, Aluminum Finish

CM2020 - Narrow SPDT Momentary, Aluminum Finish

CM1130 - SPDT Maintained, Aluminum Finish

CM2030 - Narrow SPDT Momentary, Aluminum Finish

1-877-930-1192

Camden

CM30 - Series Illuminated Key Switches

Features:

- SPDT Momentary
- EE option with 30 Second Integrated Timer

CM30 illuminated exit switches come with 2" square button (green or blue) mounted on a single gang stainless steel face plate, 2 socket / slotted screws and 2 tamper proof screws.



Stocked Product

CM30E - Green "Push To Exit"

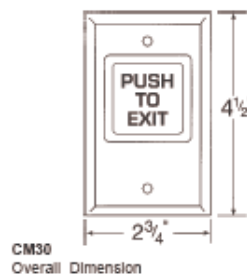

CM30
Overall Dimension

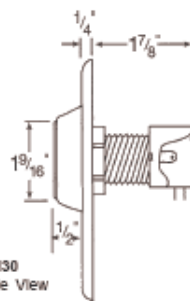

CM30
Side View

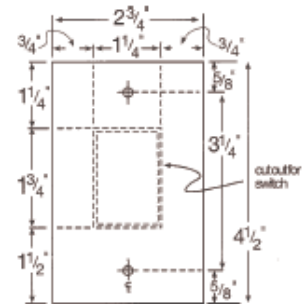

CM30
Cut Out

CM25 - All Active Jamb Switch

Features:

- mounts in aluminum jamb or in surface boxes
- meets ADA requirements
- UL approved rate 3 AMP @ 120 VAC

Stocked Product

CM25/4 - Blue "Handicap" with "Push to open"



CM25
Overall Dimension

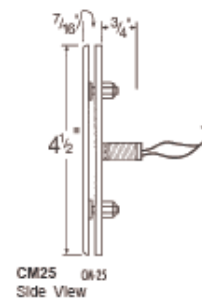

CM25
Side View

1-877-930-1192

Camden

CM830 - Remote Door Release Switch

Features:

- SPDT momentary version
- 20A @ 125/250 VAC
- Surface mounted
- Ideal for desk mounting in reception area

Stocked Product

CM830 - Rocker Switch, Black

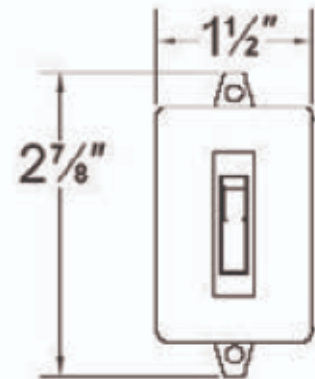

CM9000 - Vandal Resistant Exit Switches

Specifications:

CM9000 series are vandal resistant exit switches with 9/16" round all metal button DPDT switches, aluminum face plate, 2 socket / slotted screws and 2 tamper proof screws.

Stocked Product

CM9080 Single gang, DPDT, momentary, spring return

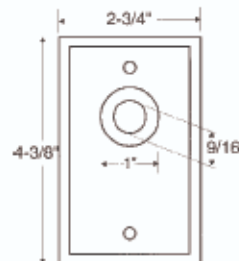

CM9080
Overall Dimension

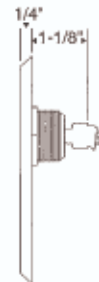

CM 9080 / CM9180
Side View



CM9180
Cut Out

1-877-930-1192

Camden

All Active Switches

CM40 - 4-1/2" Round

CM41 - 4-1/2" Round with Square back plate

CM45 - 4-1/2" Square

CM60 - 6" Round

Stocked Product

CM40-4 - 4-1/2" Round Handicap / Push to Open

CM41-4 - 4-1/2" Round Handicap with Square Back Plate / Push to Open

CM45-4 - 4-1/2" Square Handicap / Push to Open

CM60-2 - 6" Round Handicap

CM60-3 - 6" Round Handicap / Push to Open, Black



CM40



CM41



CM45



CM60

Stand Alone Digital Keypad

Features:

- Weather proof and vandal proof
- Heavy duty indoor and outdoor application
- Used with access control devices
- EE prom Memory
- Lifetime warranty
- Voltage 12VAC, 12-24 VDC
- 200 users
- CM 120is - 120 users
- CM 626 - 200 users

Specifications:

Input voltage 12 Volt or 24 Volt AC/DC
Dimension 4-1/2" H x 2-3/4" W x 7/8" D
Maximum users 120
Single gang mounted
Keypad programming

Stocked Product

CM120IS - Inside Use
CM120OS - Outside Use
CM626S - Surface Mount

CM-120IS
120 users



Accessories

PTSS Series

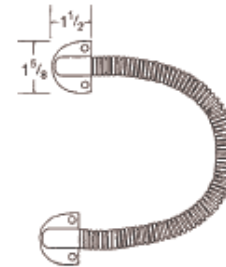

Heavy duty armoured
power transfer cable

Stocked Product

CMPTSS - 7", 12" and 18"

1-877-930-1192

Camden

Magnetic Locks CS91 Series

CX 91S-06 - 600 Lbs Surface Mounted Single Door

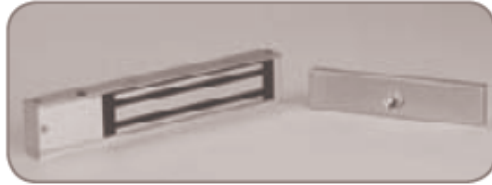

- 9-7/8" x 1-7/8" x 1"
- 500mA @ 12V
250mA @ 24V
- UL Listed

CX 91S-12 - 1200 Lbs Surface Mounted Single Door



- 10-1/2" x 2-7/8" x 1-9/16"
- 500mA @ 12V
250mA @ 24V
- UL Listed

Stocked Product

- CX91S-6 - 600 lbs Magnetic Lock
- CX91S-12 - 1200 lbs Magnetic Lock
- CX1001 - Adjustable Brackets F/1200 lbs
- CX1003 - Angle Bracket
- CX1004 - Space Bar
- CX1011 - Adjustable Brackets F/600 lbs



CX 1001
Adjustable L bracket
for 1200 lb magnets



CX 1003
Angle bracket for 600
and 1200 lb magnets



CX 1004
Spacer bar for 600
and 1200 lb magnets

Access Control

CV 32H Kit

- Online distributed processing system up to 64 doors
- Includes control panel with software, power supply, plug in transformer, 2 HID mullion proximity readers, 10 cards



CM419W Request to Exit Sensor

- Passive infra-red sensor
- Dual pyros for increased stability
- Ceiling, wall or frame mount
- Adjustable coverage for single or double door
- Adjustable - .25 to 60 second timer
- 12-24 V AC/DC
- Fail safe or fail secure operation

Stocked Product

- CV32H Kit
- CM419W Sensor

1-877-930-1192

Camden

RF Controls



CM-RX-7

- One million unique transmitter codes pre-programmed at factory
- Auto-learn receivers accept from 10 to 480 codes
- 1, 2, 3, 4, or 5 channel handheld transmitters
- Fullsize or key chain formats
- Wireless keypad models
- Exclusive wall switch ready transmitter
- 5 Wire receiver with form c relay output
- IRM option for TX-7 & TX-8 improves accuracy of transmission



RX/TX Series transmitters and receivers are ideal for varied commercial and handicap applications. Wireless operation eliminates the need to run wiring to the key switch or push button. Digital technology provides maximum range. Camden has full size and key chain transmitters, as well as wall-switch-ready and keypad models. Our receiver features the latest "push and learn" technology, and form C relay output. Camden exclusives include transmitter with Instant Response Module (pulse extender) and receivers with adjustable time delays.

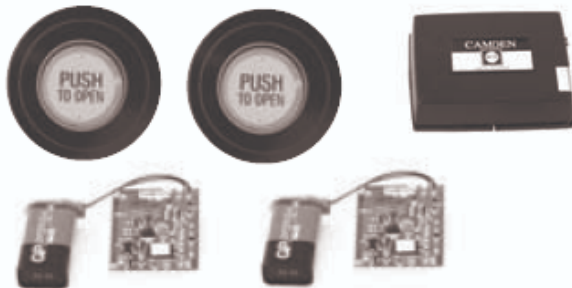

CM-RFP-404

INCLUDES THE FOLLOWING

- 2-EA CM49
- 2-EA CM-TX-7IRM
- 1-EA CM-RX-7

Stocked Product

- CMTX-1 - Hand Hold, One Channel
- CMTX-1M - Key Chain, One Channel
- CMTX-2 - Hand Hold, Two Channel
- CM-RFP404 Kit
- CM-RX-7 Receiver
- CM-RX-7TD One Channel Receiver, 30 Second Adjustable Timer

1-877-930-1192